A large, vibrant, abstract graphic consisting of numerous horizontal, slightly curved lines. The lines are colored in a spectrum from bright yellow and orange at the top, transitioning through red, magenta, and cyan, to bright blue and green at the bottom. The background is a solid, deep blue.

Aqualux  
**Dimming and lighting  
control systems**

March 2022

# DIMMING AQUALUX LED LIGHTING

- Dimming LED lighting is not as simple as incandescent lighting.
- Newer systems such as DALI are more reliable and more efficient.
- Simple, standalone digital dimming systems are cost effective and easy to install.

## 3-Wire Dimming (PWM Signal)

The preferred method for controlling wired LED fixtures, where 2-wires carry the power and a 3rd wire carries the dimming / control signal. When controlled in this way, LED fixtures can provide optimal efficiency, stability and dimming range. Many Aqualux fixtures support 3-wire dimming which can be easily interfaced to DALI, DMX or wireless control systems.

## 2-Wire Dimming (PWM Powerline)

Dimming LED products using only 2-wires requires that the fixtures or products are Constant Voltage in nature and compatible with this method. This includes most LED strip, LED festoon and some specific LED fixtures that are designed to be used with a 2-wire system. Please check individual fixture datasheets and wiring guides before assuming 2-wire dimming will work.

## Phase Cut Dimming

Phasecut (including TRIAC) dimming is not recommended for LED lighting systems. Some Aqualux products are compatible as noted below, however the majority are not. It is an outdated approach to controlling LED lighting loads with several issues (dimming ratio issues, off-peak signal interference) and there are several newer and better methods that should be used instead.

### Aqualux 10V PWM Dimming

Aqualux fittings with 10V PWM dimming are controlled via a separate dimming signal wire when it is connected to a compatible PWM source such as the DAP-04 DALI interface. **This is not the same as 0-10V or 1-10V DC analog dimming.** See Page 4 for more information.

#### Aqualux PWM Dimming

10V PWM Voltage  
1% - 100%  
500Hz

1

The dimming capability of Aqualux products is determined by the control gear code and power source.

2

Selecting the right option is important if you require a form of dimming for your lighting system.

3

To determine Aqualux dimming compatibility, locate the control gear code 'B' in your product code.

4

Refer to the table below to determine the dimming capabilities and what control gear is needed.

#### Aqualux Product Code Format

AQL-XXX-AA-**B**CCCDDEEF

#### Colour Key to the table on Page 2

##### CODE (B)

The "B" in our product code format determines the input voltage, dimming capability and wiring requirements.

##### INPUT VOLTAGE

Specifies the voltage and current type needed to power the light. There may be multiple options that affect dimming capability.

##### DIMMING CAPABILITY

If the driver and voltage combination is capable of dimming, what type of dimming it is and other details.

##### RECOMMENDED HARDWARE

Control gear required to operate the particular configuration and any dimming capability.

##### NOTES

Particular instructions directly related to the fitting and selected components.

##### WIRING DIAGRAMS

Overview of the electrical circuit, the relative position and arrangement of fittings and control gear.

**Contact Aqualux if you have any questions regarding dimming, prior to purchasing or installation**

# Aqualux Internal Control Gear - Dimming Reference

CODE	INPUT VOLTAGE	DIMMING CAPABILITY	RECOMMENDED HARDWARE	NOTES	WIRING DIAGRAM
<b>X</b>	12~24V AC 24V DC.  MultiVoltage.	DALI (via PWM 10V Signal Dimming)  24V DC Only 3-wire	Requires Meanwell DAP-04 (DALI/PWM Interface).  Can use standalone DALI dimmers or with DALI application controllers.	PWM Signal dimming. Requires PWM wire to be connected.  No PWM = 100% Output. Single Channel 10V PWM "High Side" dimming.	<b>3</b>
<b>D</b>	24V AC.	TRIAC / Phase Cut Dimming	Requires AQO 24V AC Power Source. Use Clipsal UDM450E, Dignet MEDM.	Load must be > 80% of power supply rating.	<b>30</b>
<b>C</b>	Constant Current.	Control Gear Dependant (DALI/DMX/1-10/PWM)	Requires Constant Current Power Supply.  Examples include: Meanwell LCM, ELG-C and HLG-C series.	Lights must be wired in series.  Circuit voltage must be kept below SELV DC maximums (120V).  Dimming control options depends on the power supply.	<b>26</b>
<b>Z</b>	24V DC.	4CH PWM Dimming, Common Anode	Suitable control modules include LTECH T4 Modules and DMX Interfaces.	4 Channel "Low Side" PWM dimming for RGBW systems.  Requires 500Hz (nominal) PWM signal source with common 24V+ anode.  No PWM = 0% Output.	<b>7, 15, 23, 27, 28, 29</b>
<b>E</b>	24V DC.	PWM Dimming (Power) 2-Wire	Suitable control modules include LTECH T1 CV, AQD PWM Dimmers.  Suitable power supplies include Meanwell HLG-B, Meanwell PWM drivers.	Requires PWM dimmer module or PWM dimming power supply.  Power supply will also offer additional dimming methods (0-10V, DALI, DMX etc).	<b>7, 8, 33</b>
<b>B</b>	24V DC.	DALI / PWM 10V Signal Dimming 3-wire	24V DC Only.  Utilises the Meanwell DAP-04 (DALI Interface).  Can use standalone DALI dimmers or with DALI application controllers.	PWM Signal dimming. Requires PWM wire to be connected.  No PWM = 100% Output.  Single Channel 10V PWM "High Side" dimming.	<b>3</b>
<b>L</b>	24V DC.	DALI Dimming, Integral	Integrated DALI compatible LED driver.  Requires 2-wire DALI signal control in addition to 24V DC power.  Requires DALI application controller or standalone dimmer control unit.	Check DALI wiring regulations when used together with SELV lighting systems.	<b>32</b>
<b>M</b>	MR16.	Lamp Dependant.	Lamp Dependant.	Lamp Dependant.	-
<b>G</b>	GU10.	Lamp Dependant.	Lamp Dependant.	Lamp Dependant.	-
<b>F</b>	240V AC.	Control Gear Dependant.			-
<b>H</b>	24V AC/DC.	PWM (Power) Dimming	Suitable control modules include LTECH T1 CV, AQD PWM Dimmers.  Suitable power supplies include Meanwell HLG-B dimming power supplies.	24V DC PWM Power dimming.  Requires PWM dimmer module or PWM dimming power supply.	-
<b>J</b>	12V DC.	PWM (Power) Dimming	Suitable control modules include LTECH T1 CV, AQD PWM Dimmers.  Suitable power supplies include Meanwell HLG-B dimming power supplies.	12V DC PWM Power dimming possible.  Requires PWM dimmer module or PWM dimming power supply.	-
<b>K</b>	24V DC.	Non Dimming.			-
<b>Y</b>	12~24V AC / 24V DC	Non Dimming.	2 (Power)		-
<b>W</b>	24V DC.	Wireless DMX	2 (Power)		-

# LED Strip and String Lighting reference guide

PRODUCT GROUP	INPUT VOLTAGE	DIMMING CAPABILITY	RECOMMENDED HARDWARE	WIRING DIAGRAM
AQS NEON FLEX AND COB STRIP  (MONO) AQF FESTOON AQF FAIRY	24V DC	PWM (Power) Dimmable 2-Wire	<b>DALI Dimming</b> - 24V DALI Compatible PSU eg. Meanwell -DA PSU - DALI Standalone Dimmer eg. AQD-400-ZEN - or integrated DALI system  <b>Phasecut Dimming</b> - 24V Phasecut Compatible PSU eg. AQD-PS-PDV Series - Compatible phasecut dimmer eg. Diginet MEDM  <b>SELV PWM Dimming</b> - 24V Non-dimmable PSU eg. AQD24 series - Low-voltage PWM Dimmer eg. AQD-400-T3CV Series  <b>0-10V Dimming</b> - 24V 0-10V Compatible PSU eg. Meanwell HLG-B Series - 0-10V Dimming Unit eg. AQD-400-DIM-001  <b>DMX Dimming</b> - 24V Non-dimmable PSU eg. AQD24 series - DMX > PWM Interface Module eg. AQD-400-LT844 - DMX Controller	<b>31</b>
AQF FESTOON	24V AC	TRIAC / Phase Cut Dimming.	AQO 24V AC Power Supply + Compatible Phase Cut Dimmer eg. Clipsal UDM450E, Diginet MEDM	<b>30</b>
AQS NEON FLEX AND COB STRIP  (RGB/RGBW)	24V DC	3CH / 4CH PWM (Power) Dimmable 4-Wire (RGB) 5-Wire (RGBW) RGB/RGBW Controller Reqd.	<b>DMX Control</b> - 24V Non-dimmable PSU eg. AQD24 series - DMX > PWM Interface Module eg. AQD-400-LT844 - DMX Controller  <b>Remote RGB/RGBW Control</b> - 24V Non-dimmable PSU eg. AQD24 series - Low-voltage PWM Dimmer eg. AQD-400-T3CV Series - RF Remote Control eg. AQD-400-T3/T4	<b>4, 6, 11, 13, 17, 19, 20, 21, 22</b>

## CBUS Dimming

The ability of CBUS to dim LED lighting system depends on the modules available within the CBUS system and the type of dimming required by the LED driver or power supply.

Dimming with CBUS:

- Preferably, use a CBUS/DALI gateway and a DAP-04 for compatibility with Aqualux 10V PWM dimming.
- Optionally, use a Phasecut CBUS dimming module with a compatible Phasecut power supply.

### Universal (Phasecut) Dimming Module

*C-Bus DIN Rail Mounted DALI Gateway for 2 Dali Networks*  
Item Number: 5502DAL

### CBUS / DALI Gateway

*DIN Rail Mounted, Universal, 240V AC, 4 Channel, 2.5A*  
Item Number: L5504D2UP

# Technical Information

## 2-WIRE PWM (POWER) DIMMING

PWM dimming with 2-wires modifies the output of a DC power supply via PWM (Pulse-width modulation). It modulates how often the current is on or off hundreds of times per second.

As the human eye cannot perceive frequencies this fast, the effect is an apparently stable variation of the output light level.

PWM power dimming can be achieved by using compatible power supplies that will require their own dimming control input. It can also be achieved by using a PWM module that sits between the power supply and lighting product and modifies the power output.

PWM Power dimming is common in LED strip lighting products and operates across any number of channels (eg. White, Tuneable White, RGB, RGBW).

The benefits of PWM power dimming are that it is relatively straightforward requiring no additional wires and that it works independent of the load rating of the power supply.

The drawbacks are that it will generally only work for LED products that are constant voltage in nature. This usually means it will not work for any LED product that has its own internal DC-DC LED driver.

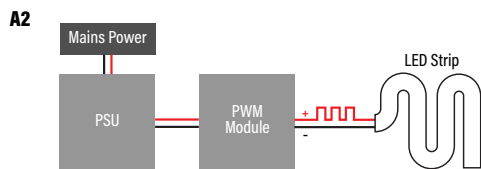
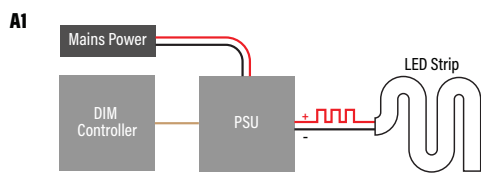

## 3-WIRE PWM (SIGNAL) DIMMING

PWM Signal dimming directly modifies the output of an LED driver, usually an internal constant current driver inside a light fitting but also sometimes a DC Power Supply output.

The driver or power supply requires a separate control signal wire that the PWM signal is delivered with. The PWM signal then directly modifies the output of the driver and the light level.

The advantages of this approach are that multiple individual fittings can be controlled with the same dimming signal and that it operates independent of the internal LED voltage. A variety of types of fittings can be controlled synchronously in the same manner.

It is also more efficient than 2-Wire PWM (Power) dimming in that it is directly modifying the output current of the LED driver, rather than varying the voltage to a LED circuit with a current-limiting resistor.

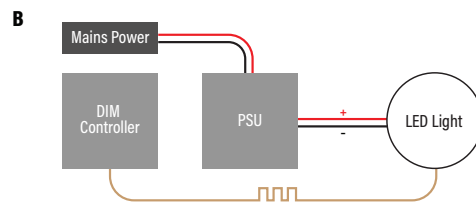

## DALI

DALI (Digital Addressable Lighting Interface) is a modern lighting control protocol. It allows for up to 64 devices in a single network and each device to be individually addressed and controlled.

The benefits of DALI are relative ease of deployment and commissioning, with each fixture or driver assigned an address and independently controlled.

The drawbacks include the requirement for additional components such as a DALI bus power supply and either a standalone controller or a master application controller.

Additionally, wiring rules specify that the control cables (although carrying only 16V) must be treated as 240V.

This simplifies wiring in mains powered lighting systems but may complicate requirements in SELV systems.

Aqualux fittings that are DALI compatible typically use a DALI/PWM interface to provide this control. This means that control is available down to the power supply group rather than individual fitting.

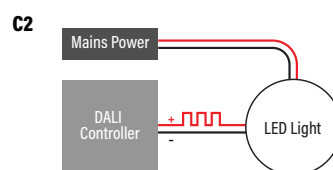
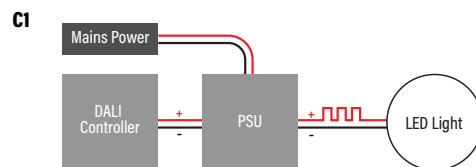

# Technical Information

## DMX512

DMX (Digital Multiplex) is a common digital protocol based on the RS485 serial interface for the control of entertainment lighting and architectural lighting systems.

Developed initially for linking theatrical lighting and effects systems to central controllers, it has expanded to include many other functions.

DMX requires a separate set of control cables to carry the data signals from a central controller to the lighting systems and power supplies. It can be used with both low voltage and mains lighting products as the control system is completely separate to the lighting power supply system.

The benefits of DMX512 are that it is a widely used and well understood system with many compatible control products.

Very long signal cable runs are also possible, up to 1km or more. Wireless DMX equipment is also available.

The main drawback is that DMX requires additional control equipment and adds complexity to a system beyond what is typical for residential applications. Many fittings will also require an interface module to convert the digital DMX512 signal to PWM Signal.

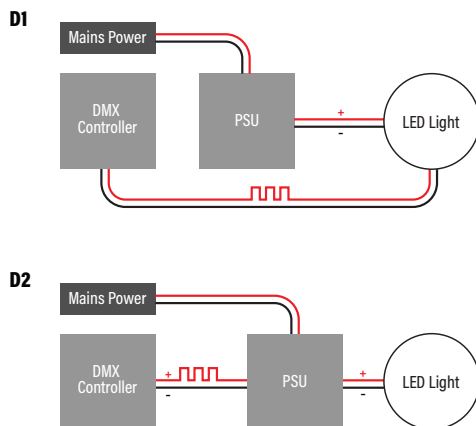

## ARTNET

ArtNET is a protocol for transmitting DMX/RDM signals over Ethernet. It can make the deployment of a DMX solution a lot easier as it can utilise existing infrastructure.

## PHASE CUT / TRIAC

Phase cut dimming includes both TRIAC based dimming (leading edge) and trailing edge approaches.

There are also “universal” or adaptive dimmers that can determine the most appropriate mode for the detected load. The benefits of phase-cut dimming are that it is simple to install and widely understood by most contractors.

The drawbacks include incompatibility with many LED products and varying performance that depends on the combination of dimmer, power supply and LED light.

Phasecut dimming is also susceptible to interference from off-peak ripple or control signals in areas that exhibit this problem.

Some manufacturers recommend only certain combinations of dimmers and power supply units.

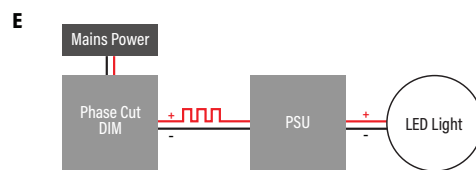

## MESH NETWORKS (ZIGBEE, CASAMBI, SILVAIR)

There are a growing number of mesh network protocols intended for wireless control of lighting and other building systems. Casambi and Silvaire operate using Bluetooth mesh networks, whereas Zigbee utilises its own radio communication method.

Casambi in particular is growing in popularity and Aqualux will soon be able to offer a range of options for control of fittings and strip lighting with Casambi products.

